



KEY-LINK[™]
FENCING & RAILING

ALUMINUM RAILING





RAILING SHOULD NEVER BE AN AFTERTHOUGHT

Railing is the first thing you see when you step onto your deck, it's essential for safety, and it literally surrounds you at every turn. Choose railing that sets the tone and matches the quality you want in the rest of your outdoor living space.

Key-Link aluminum railing is the premier choice for both residential and commercial spaces. Contractors and builders praise Key-Link's quality and the thoughtful details that make it easy to install. Home and business owners love Key-Link's unique design and premium craftsmanship.

 **Manufactured in the USA**
Key-Link's products are proudly designed and manufactured in the USA to ensure a quality fit and finish.

WHAT IS KEY-LINK QUALITY?

- AAMA 2604 standard powder coating on railing and accessories to promote weatherability, with AAMA 2605 standard available for additional protection
- IBC or IRC code compliance for peace of mind and safety
- High-quality aluminum with vinyl inserts to hold balusters snugly and prevent rattling
- Limited lifetime warranty and 5-year prorated labor warranty



Contents

- American Series 4-7
- Outlook Series 8-11
- Chesapeake Series 12-15
- Railing Overview 16-17
- Brackets 18-19
- Fascia Mount Brackets..... 20
- Horizontal Cable Fittings... 20
- Posts, Wrap, Caps & Trim ... 21
- ADA Handrail 22
- Placid Point Lighting..... 23

AMERICAN SERIES

BRING TIMELESS LOOKS HOME

Key-Link's top-selling aluminum railing has a clean flat-top profile for a modern yet classic style. This versatile railing complements any design and can be paired with aluminum balusters or with Key-Link's horizontal or vertical cable infill for a truly custom look.





AMERICAN SERIES

PRODUCT DETAILS

- Level and stair rail lengths come in 5', 6', 7' or 8' sections
- Available in 36" or 42" heights
- Meets IRC and IBC (42" only) code requirements
- Boxed sections include top and bottom rails, mounting brackets and hardware, infill and the installation guide

*Except Horizontal Cable

Pictured Above:

- a. Textured Black with Horizontal Cable Infill
- b. Textured White with Black Square Infill
- c. Textured Black with Vertical Cable Infill

PROFILE

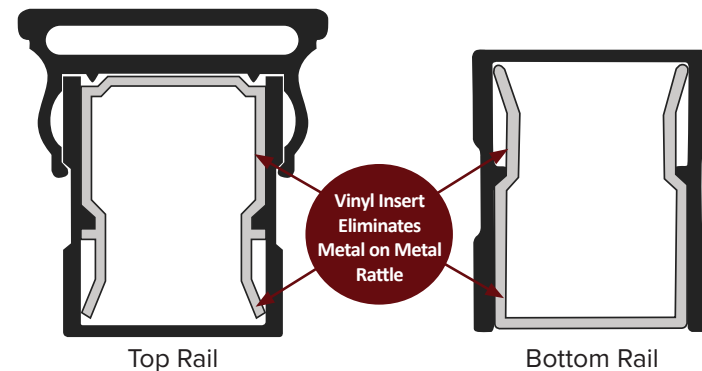

STANDARD COLORS



INFILL OPTIONS

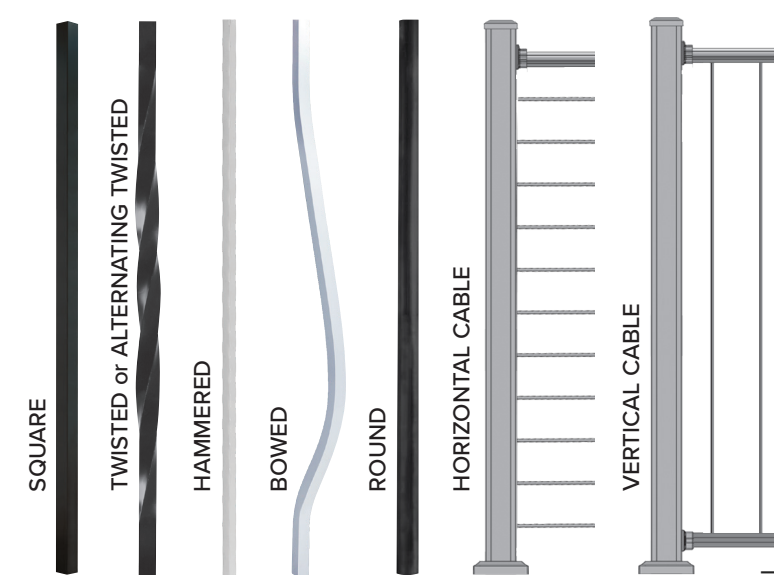

OUTLOOK SERIES

OPEN YOUR SPACE WITH STYLE

The slim-profile Outlook railing works in small or large spaces thanks to its sleek, go-anywhere design and unobtrusive footprint. Outlook's clean lines help define and open a space, providing both security and elegance to outdoor living.





OUTLOOK SERIES

PRODUCT DETAILS

- Level rail lengths come in 5', 6', 7' or 8' and stair rail lengths come in 4', 5' or 6'
- Available in 36" or 42" heights
- Meets IRC and IBC (42" only) code requirements
- Boxed sections include top and bottom rails, mounting brackets and hardware, infill and the installation guide

PROFILE

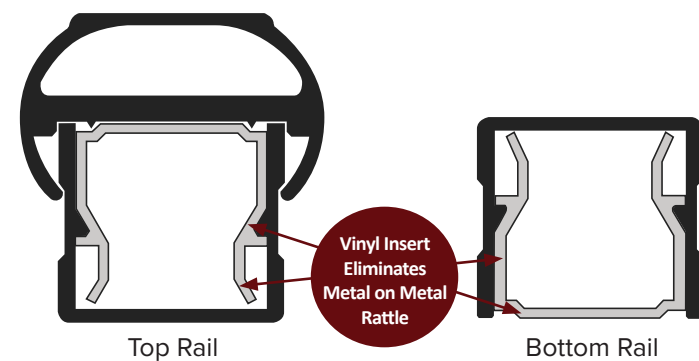

STANDARD COLORS



AVAILABLE INFILL

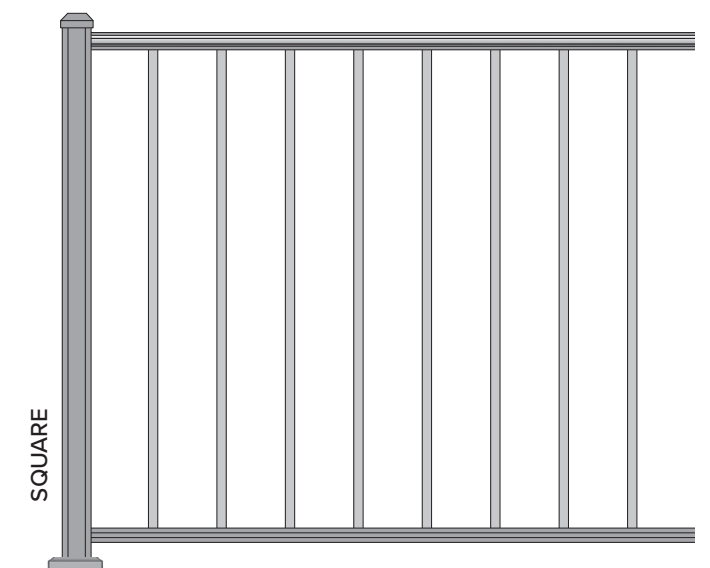

Pictured Above:

- a. Matte Black with Square Infill*
- b. Textured White with Square Infill*
- c. Matte Black with Square Infill*

CHESAPEAKE SERIES

ENTERTAIN WITH ELEGANCE

This well-designed drink rail brings high-end form and function to your outdoor living. You and your guests will enjoy the convenience of having a place to rest drinks and plates, while your contractor will appreciate how quickly and easily the deckboard attaches to our specially designed profile.

Chesapeake coordinates with Key-Link's American Series for those who wish to use deckboard rail and standard railing together.





CHESAPEAKE SERIES

PRODUCT DETAILS

- Level and stair rail lengths come in 6' or 8' sections
- Available in 36" or 42" heights
- Meets IRC and IBC (42" only) code requirements
- Boxed sections include top and bottom rails, mounting brackets and hardware, infill and the installation guide

*Except Horizontal Cable

Pictured Above:
 a. Textured Black with Horizontal Cable Infill
 b. Textured Bronze with Square Infill
 c. Matte Black with Square Infill

PROFILE

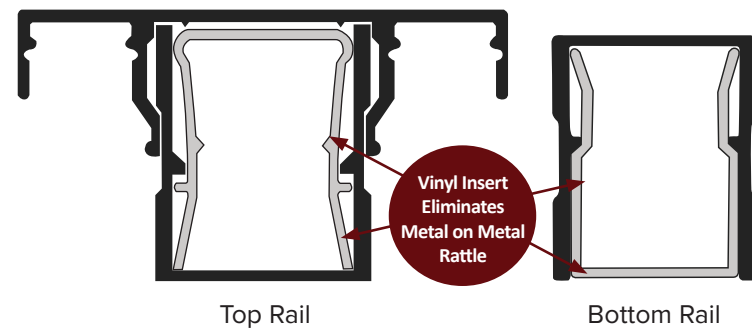

STANDARD COLORS



INFILL OPTIONS

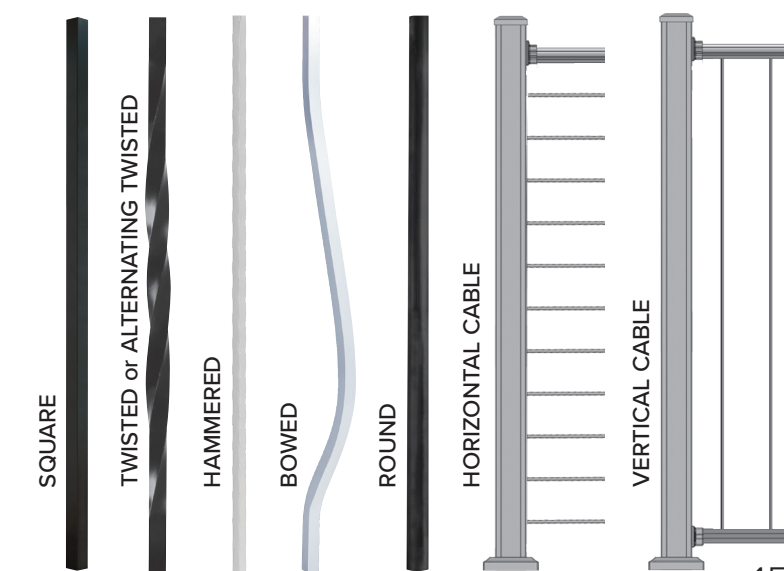

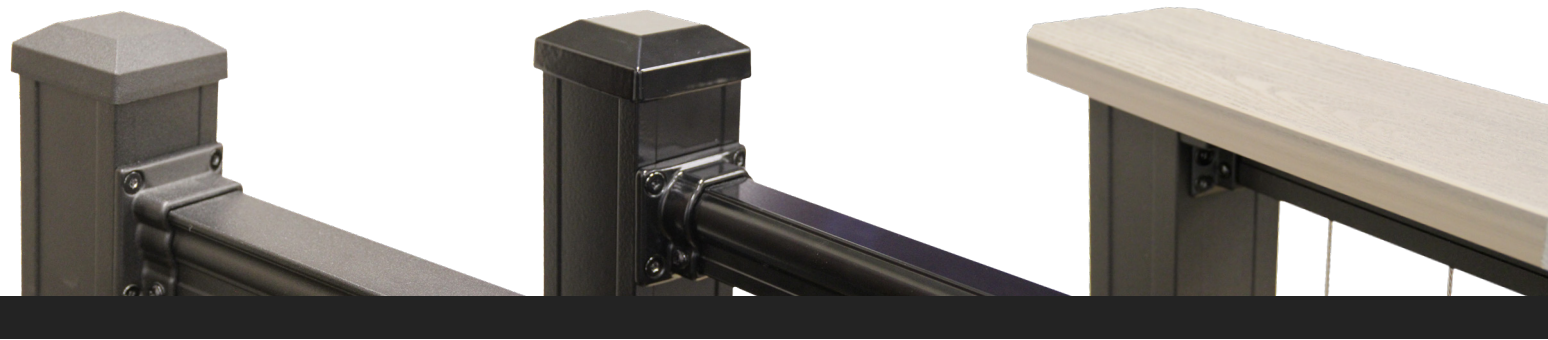

AMERICAN SERIES

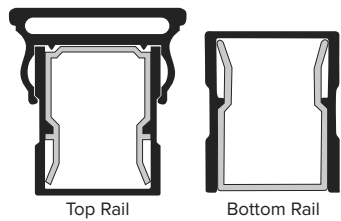

- 1 3/4" W x 1 7/8" H Flat Top Rail
- Railing Height Options: 36" - 42"
- Railing Length Options: 5' - 6' - 7' - 8'
- Square Balusters are 3/4"

OUTLOOK SERIES

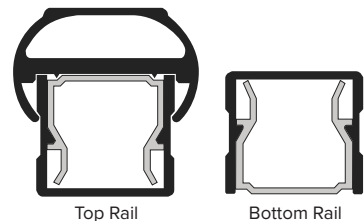

- 1 1/2" W x 1 1/2" H Top Rail
- Railing Height Options: 36" - 42"
- Railing Length Options: 5' - 6' - 7' - 8'
- Square Balusters are 5/8"

CHESAPEAKE SERIES

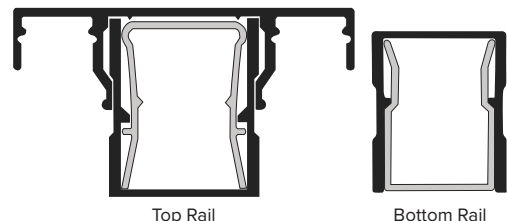

- 2 7/8" x 1 1/8" Top Rail (Deckboard Not Included)
- Railing Height Options: 36" - 42"
- Railing Length Options: 6' - 8'
- Square Balusters are 3/4"

INFILL OPTIONS

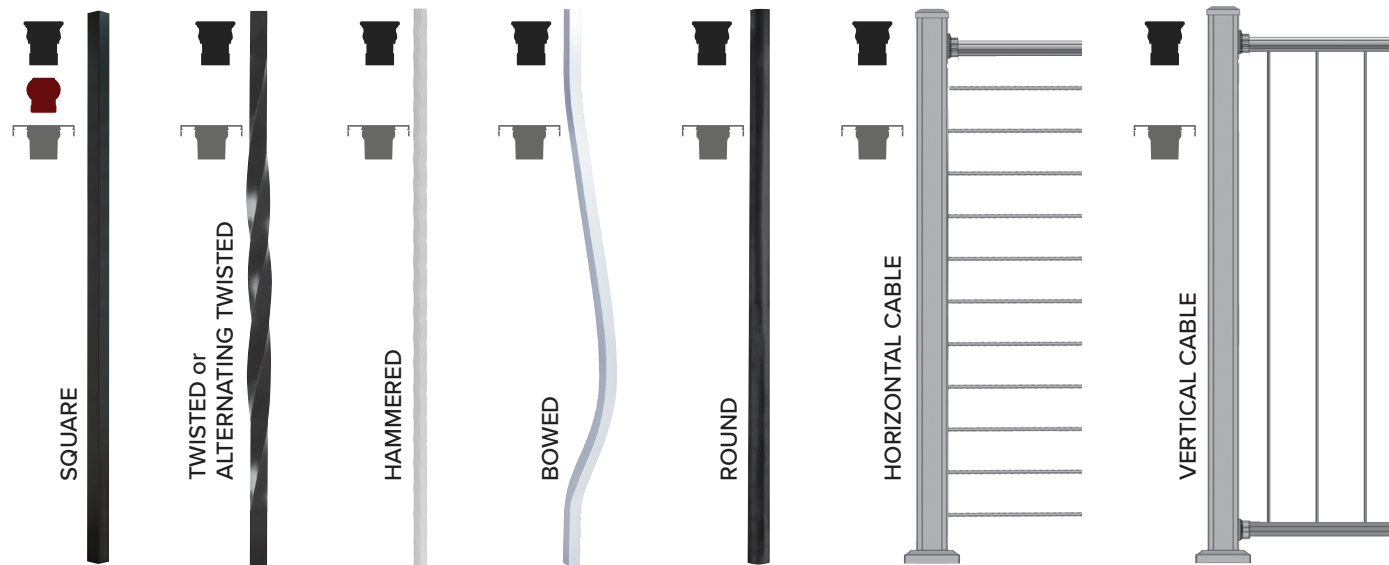

KEY-LINK'S STANDARD COLOR OPTIONS

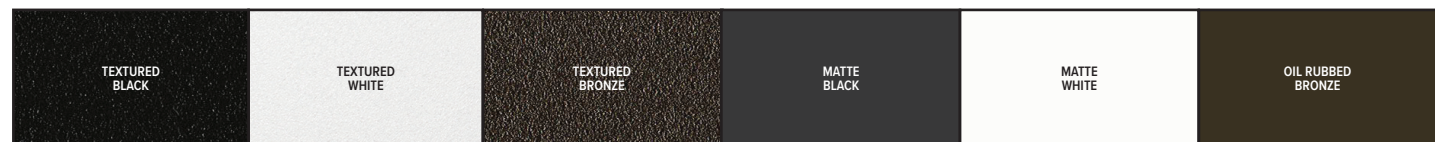

KEY-LINK'S SPECIAL ORDER COLOR OPTIONS*



KEY-LINK'S COASTAL UPGRADE COLOR OPTIONS*



AMERICAN SERIES



OUTLOOK SERIES



CHESAPEAKE SERIES



*A slight difference in color is expected between AAMA 2604 and AAMA 2605 finishes. Please consult your sales representative for swatches and Special Order and Coastal Upgrade pricing.

WHAT'S YOUR ANGLE?

Key-Link's brackets can help take your railing in a new direction!
 These powder coated, self-centering brackets can handle installation angles from 0-52° horizontally and 0-52° vertically, so no matter your installation challenge, Key-Link has a bracket.



OUTLOOK SERIES BRACKETS & WEDGES

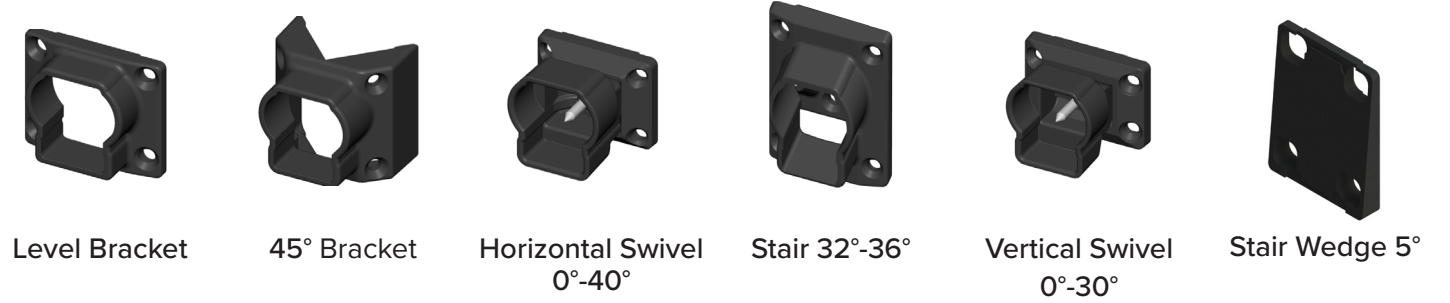

CHESAPEAKE SERIES BRACKETS & WEDGES

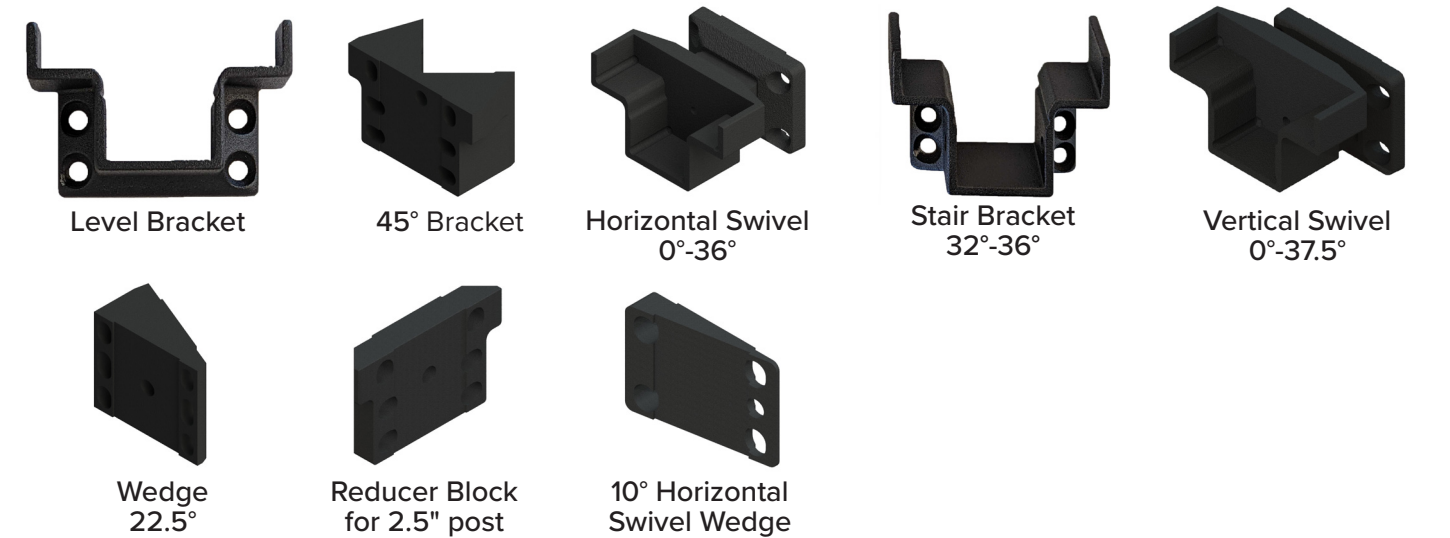

AMERICAN SERIES BRACKETS & WEDGES

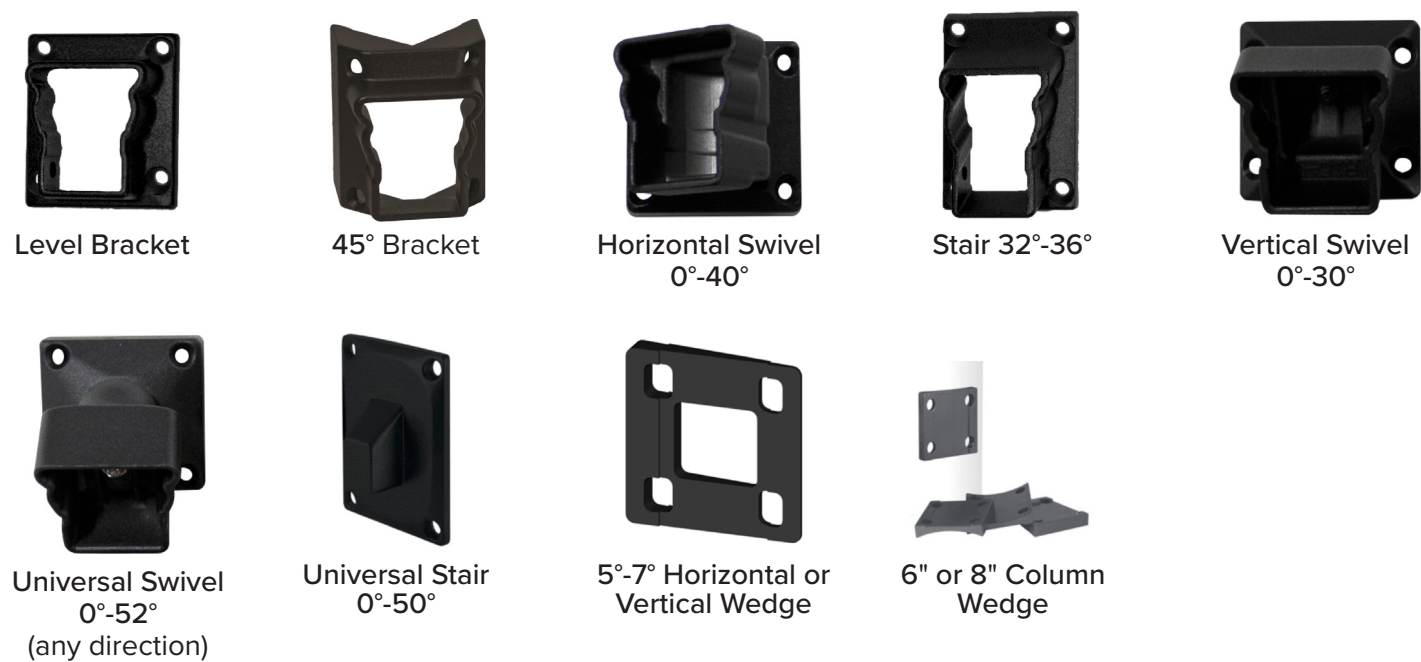

VERTICAL BRACKET ANGLE GUIDE

Find the vertical angle you need, then note the appropriate bracket.

- Universal Swivel = 0°-52°
- Vertical Swivel = 0°-30°
- Stair = 32°-36°
- Vertical Wedge = 5°-7°

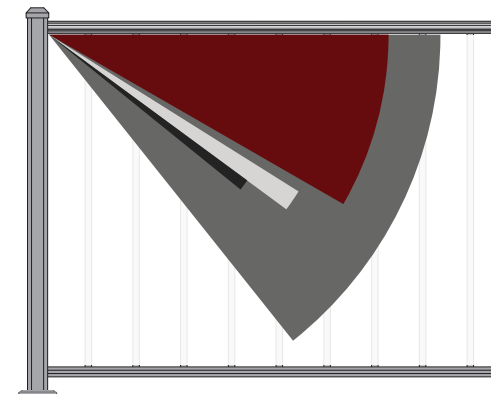

HORIZONTAL BRACKET ANGLE GUIDE

Find the horizontal angle you need, then note the appropriate bracket.

- Universal Swivel = 0°-52°
- Horizontal Swivel = 0°-40°
- 45° Bracket = 45°
- Horizontal Wedge = 5°-7°

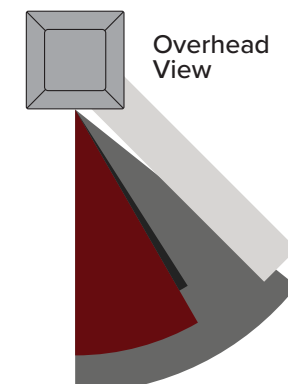

ACCESSORIES

FASCIA MOUNT BRACKETS

Key-Link's solidly crafted fascia mounting brackets let you move railing posts to the fascia for additional deck space and a unique aesthetic. For each linear foot of railing, fascia mounting gives you an extra ½ square foot of space compared to traditional surface mounting.

Available for both 2½" and 3¼" posts

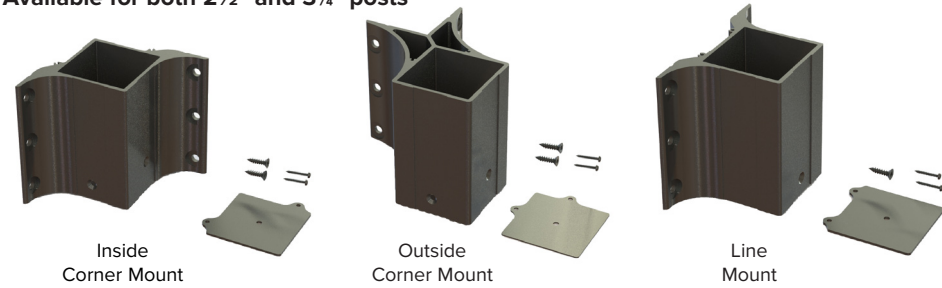

STANDARD COLORS



Special order colors also available.

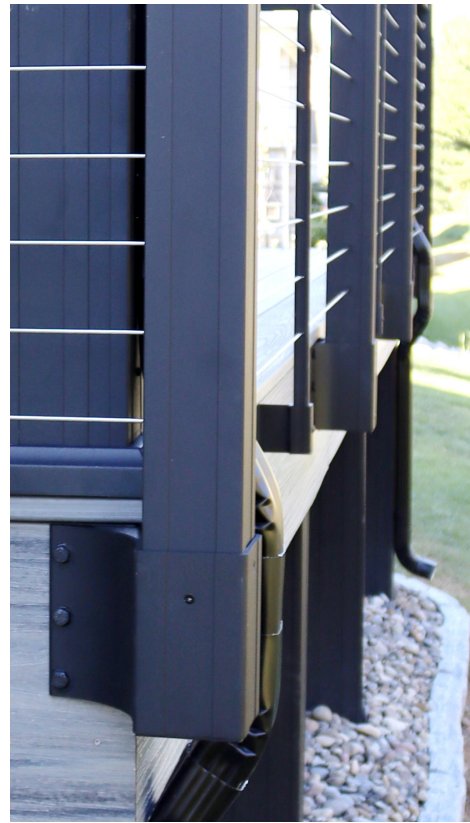

POSTS

Key-Link's powder coated posts come with a leveling plate for ease of installation even on a non-level surface. Each post is grooved to receive our self-centering brackets.

Available in 2½" and 3¼" posts

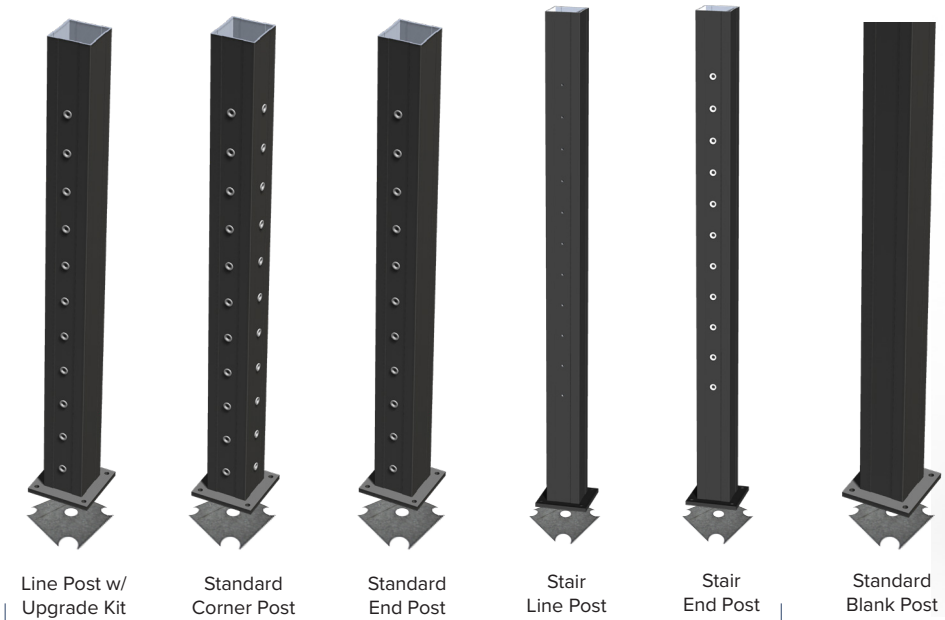

HORIZONTAL CABLE POSTS

Crossover Post

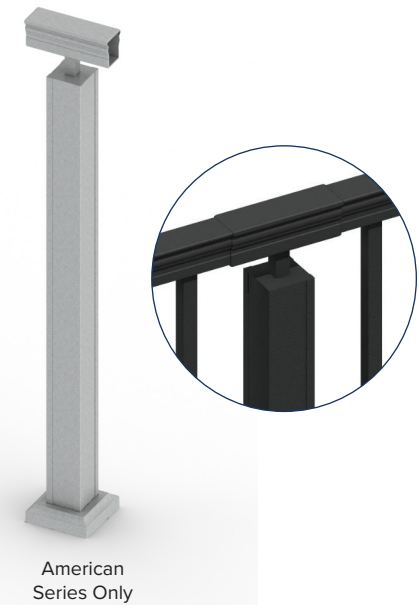

American Series Only

HORIZONTAL CABLE FITTINGS

Cable fittings allow you to turn wood, aluminum, composite, or masonry posts into vehicles for beautiful on-trend horizontal cable railing.

These slimmed down fittings have full tensioning capacity for safety and security and require only a few standard tools for installation.

For use on new construction or retrofit projects.

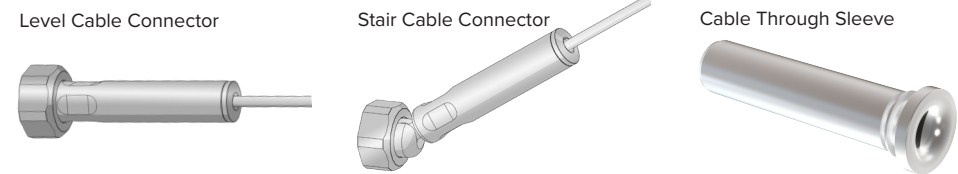

Stainless Steel Cable

Our Cable is Made From Grade 316 Stainless Steel & Features a 1/8" Diameter w/1 x19 Strand Construction.



Installation Tools

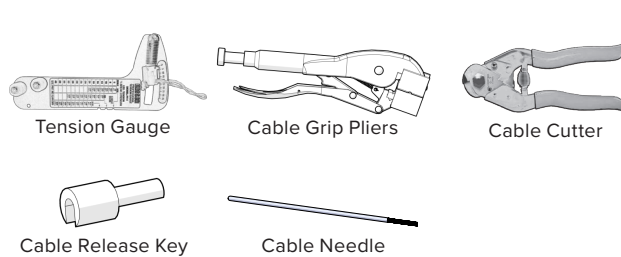

Cleaner and Protectant



POST WRAP & PORCH POSTS

Complement your railing project and support your porch roof with handsome powder-coated post wrap or porch posts. All items are color matched to our railing lines, and unlike wood, these posts will not crack, rot, or ever need to be painted.

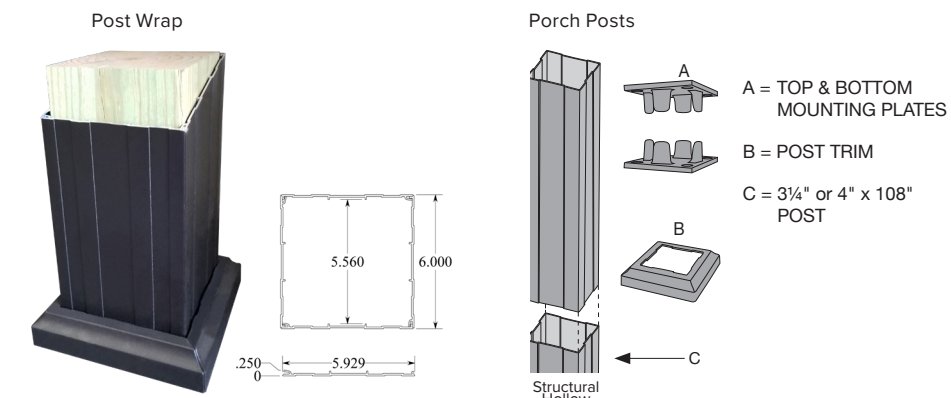

POST CAPS & TRIM

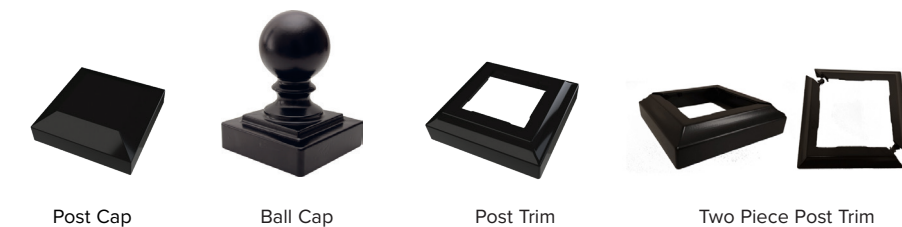

ADA ALUMINUM HANDRAIL

ADA Aluminum Handrail adds safety and security without compromising on looks! This handrail is designed to coordinate perfectly with Key-Link's existing railing for a beautiful, functional, and safe railing system.



STANDARD COLORS



SPECIAL ORDER COLORS



COASTAL UPGRADE COLORS



END CAP	
P - LOOP RETURN	
ADA HANDRAIL BRACKET	
HANDRAIL CONNECTOR WITH RING	
5° RADIUS ELBOW (24")	
34° RADIUS ELBOW (24")	
STRAIGHT HANDRAIL (104" or 120")	
90° RADIUS ELBOW (24")	
6" CORNER MOUNTING BRACKET	
0° - 90° UNIVERSAL ELBOW	
OUTSIDE ELBOW	
ALUMINUM 90° ELBOW BRACKET	
STRAIGHT ALUMINUM WALL BRACKET WITH RING	
ALUMINUM GATE RETURN (+ O)	
UNIVERSAL ELBOW HANDRAIL BRACKET	

BRING YOUR SPACE TO LIGHT

Key-Link's electrical engineers and experts have refined our lights for a long-lasting and easy-to-use system that brings exceptional outdoor lighting to your deck or porch.



STANDARD COLORS

Powder-coated die-cast aluminum



SPECIAL ORDER COLOR OPTIONS



POST & ACCENT LIGHTS

Sizes available for 2½", 3¼" and 4" Posts

POST CAP LIGHTS

3000k LED

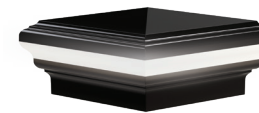

PYRAMID



DECORATIVE

POST CAP DOWNLIGHTS

3000k LED



PYRAMID

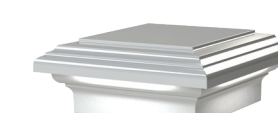

DECORATIVE

POST & STAIR ACCENT LIGHT

3000k LED

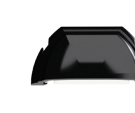

POST CAPS (NO LIGHTS)



PYRAMID



DECORATIVE

UNDER RAIL LIGHTING

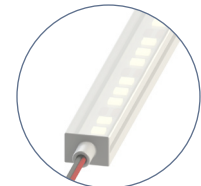

Only available for Chesapeake Series

LIGHTING ACCESSORIES

LIGHTING CONTROL HUB & POWER SUPPLY



- Timer lets you choose 1-9 hours of light, or dusk-to-dawn
- Dimmer mode with 9 brightness levels
- Adjustable photocell sensor to control for ambient light
- **Walk Away** feature for safe exiting before lights go out
- Aluminum housing to match railing
- Power Supply available in 60w or 120w
- Expandable Power Splitter available for both 60w or 120w power supply

POST LIGHT WIRE KIT

- KIT INCLUDES:
- Staples
 - 2-way splitter
 - 5' and 9' wire extensions

WIRE EXTENSIONS, WIRE SPLITTERS

- WIRE EXTENSIONS:
- 2', 5', 9' Lengths Available
- WIRE SPLITTER KITS:
- 2-Way Kit: Includes (1) 8" input cable to (2) 8" output cables
 - 3-Way Kit: Includes (1) 8" input cable to (3) 10" output cables

2" POST ADAPTER

- Made to fit fence posts
- Fits 2" Posts
- Uses 2½" Cap for 2" Post





KEY-LINK™

FENCING & RAILING



[keylinkonline.com](https://www.keylinkonline.com)

260 Jalyn Drive, New Holland, PA 17557

717-355-7130 // Toll Free: 888-704-7130

Fax: 717-355-7139

