



KEY-LINK™
FENCING & RAILING

CABLE RAILING





EXCEPTIONAL STYLE, OUTSTANDING PERFORMANCE.

If you're dreaming of beautiful, stress-free outdoor living spaces, our low-maintenance aluminum railing, designed to provide long-lasting attractiveness and safety, is one way to make that outdoor dream a reality. With its wide variety of colors and styles, Key-Link's aluminum railing is appreciated by homeowners and builders alike. All of Key-Link's railing is engineered to our exacting standards and fabricated and tested in the USA.



Manufactured in the USA

Key-Link's products are proudly designed and manufactured in the USA to ensure a quality fit and finish.

WHAT IS KEY-LINK QUALITY?

- AAMA 2604 standard powder coating on railing and accessories to promote weatherability, with AAMA 2605 standard available for additional protection
- IBC or IRC code compliance for peace of mind and safety
- High-quality aluminum with vinyl inserts to hold balusters snugly and prevent rattling
- Limited lifetime warranty and 5-year prorated labor warranty

Contents

Horizontal Cable.....	4-9
Vertical Cable.....	10-13
Post Caps, Trim.....	14
Posts, Porch Posts.....	14
ADA Handrail.....	15
External Cable Fittings.....	16-17
Placid Point Lighting.....	18-19

*Pictured above:
Textured Black with Horizontal Infill*

HORIZONTAL CABLE

A MODERN VIEW

Sleek and modern horizontal cable continues to be one of the most popular choices on the market. Contractors appreciate Key-Link's system for its ease of installation; homeowners love the look and maintaining their unobstructed views.





2 1/2" Posts Now Available

HORIZONTAL CABLE

PRODUCT DETAILS

- Available in 36" & 42" h x 6' & 8' sections
- Pre-drilled line, corner, and end posts
- Requires only single post at corners
- Meets IRC and IBC (42" only) code requirements
- Comes as a boxed section with center baluster and top rail (cable rolls available separately)

Pictured Above:
 a. Chesapeake in Matte White
 b. American in Textured Black
 c. American in Matte Black

STANDARD COLORS



RAILING STYLES

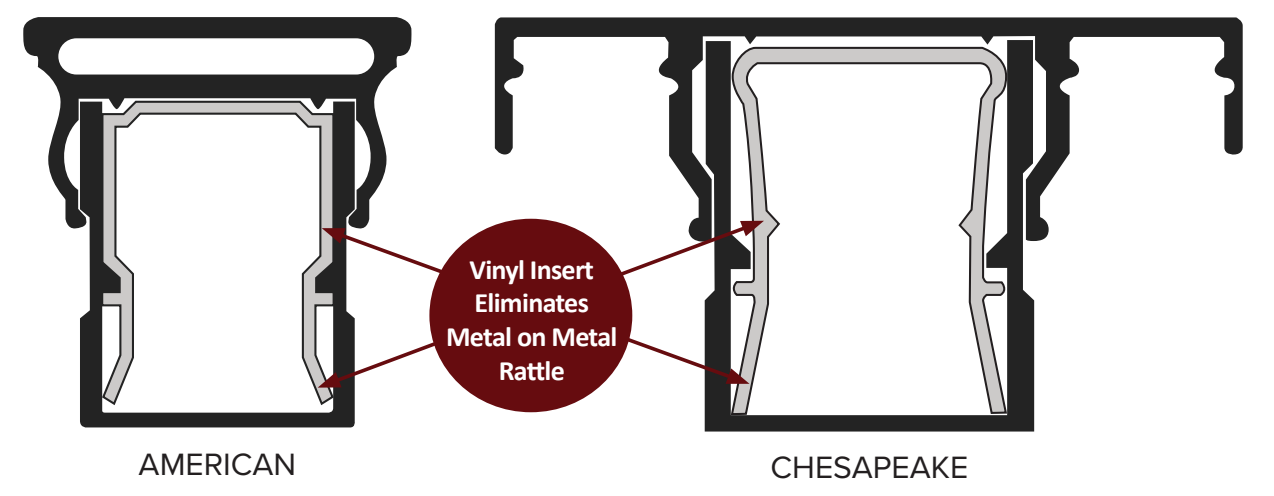

HORIZONTAL CABLE SYSTEM

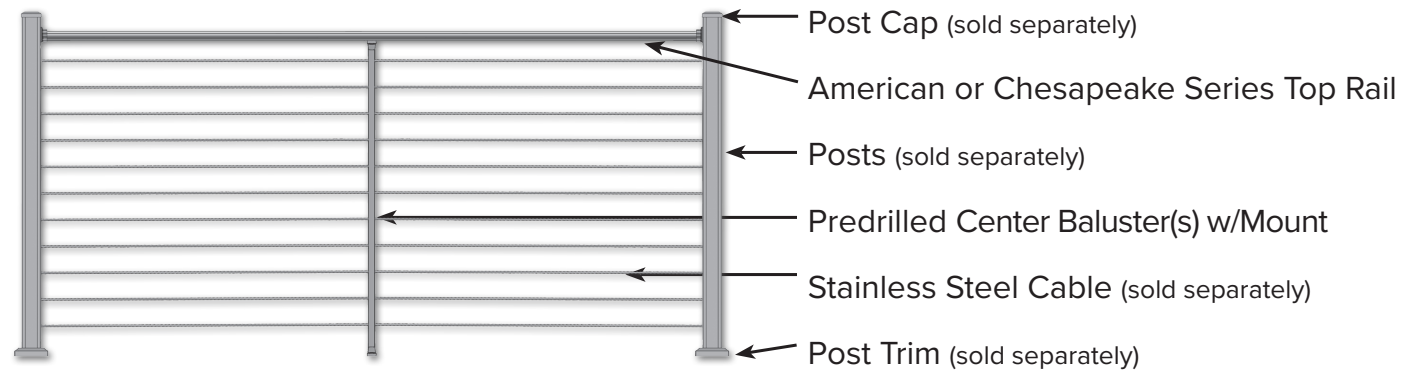

Railing Boxed Section Includes:

American or Chesapeake Top Rail, Center Baluster(s) & Mounts, Top Rail Mounting Brackets
Cable, posts, caps and trim sold separately.

AVAILABLE POST OPTIONS

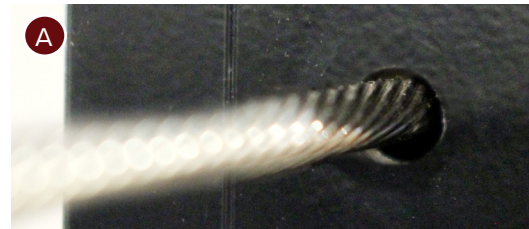
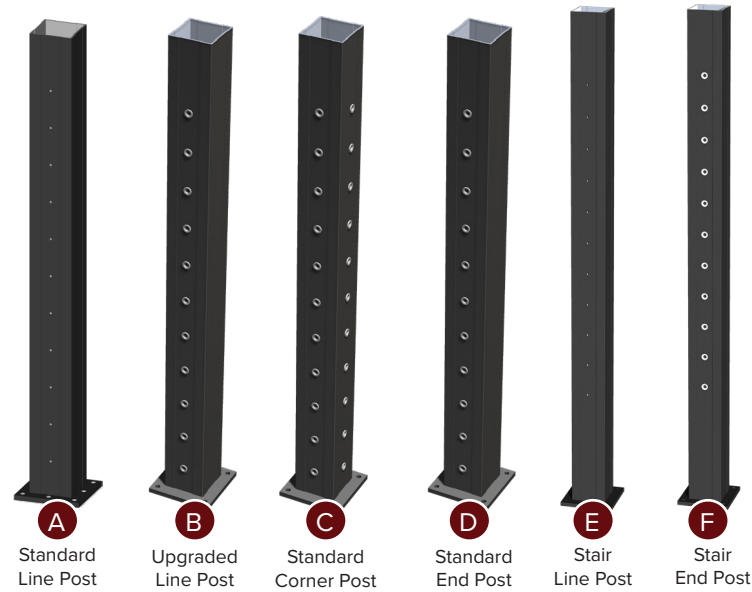

Used on level surfaces with no cable angle changes.

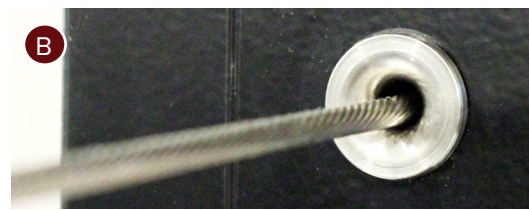

Use the upgraded line post any time your cable is angled between 90° and 180°, for transitions down stairs, or for a cohesive stainless steel aesthetic.



STAINLESS STEEL CABLE

Stainless Steel Cable

Our Cable is Made From Grade 316 Stainless Steel & Features a 1/8" Diameter w/1 x19 Strand Construction.



EXTERNAL CABLE FITTINGS

Designed for use in wood post or composite post projects.

Level Cable Connector

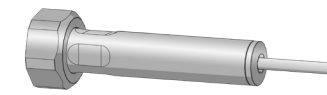

Stair Cable Connector

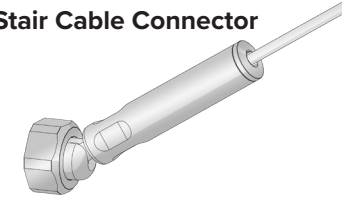

Cable Through Sleeve

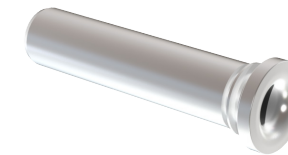

For use on new construction or retrofit projects.



INSTALLATION TOOLS

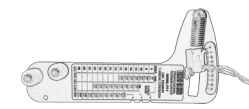

Tension Gauge

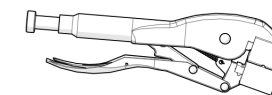

Cable Vise Grip

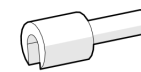

Cable Release Key

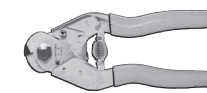

Cable Cutter



Cable Needle

CLEANERS & PROTECTANT*



Stainless Steel & Chrome Cleaner



Stainless Steel Cleaner & Protectant

*For preventative care and cleaning. See the cable rail cleaning guidelines on our website for more information.

POST CAPS AND TRIM

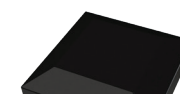

Post Cap



Ball Cap

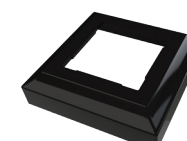

Post Trim



Two Piece Post Trim

STRUCTURAL PORCH POSTS



Line Porch Post Drilled



End Porch Post with Pre-Installed Fittings



Corner Porch Post with Pre-Installed Fittings

VERTICAL CABLE

A FRESH TAKE

For those who want cable with a different spin, Key-Link's vertical cable system is the premiere choice. The cable comes pre-installed from our plant for installers' convenience, and the addition of stainless steel support balusters give it a seamless contemporary style that homeowners love.





a



b



c

VERTICAL CABLE

PRODUCT DETAILS

- Available in 36" & 42" h x 6' & 8' sections
- No drilling required for standard installations
- Cable comes pre-installed
- Meets IRC and IBC (42" only) code requirements
- Conveniently boxed as a section

Pictured Above:
 a. American in Textured Black
 b. American in Textured Black
 c. American in Textured Black

STANDARD COLORS



RAILING STYLES

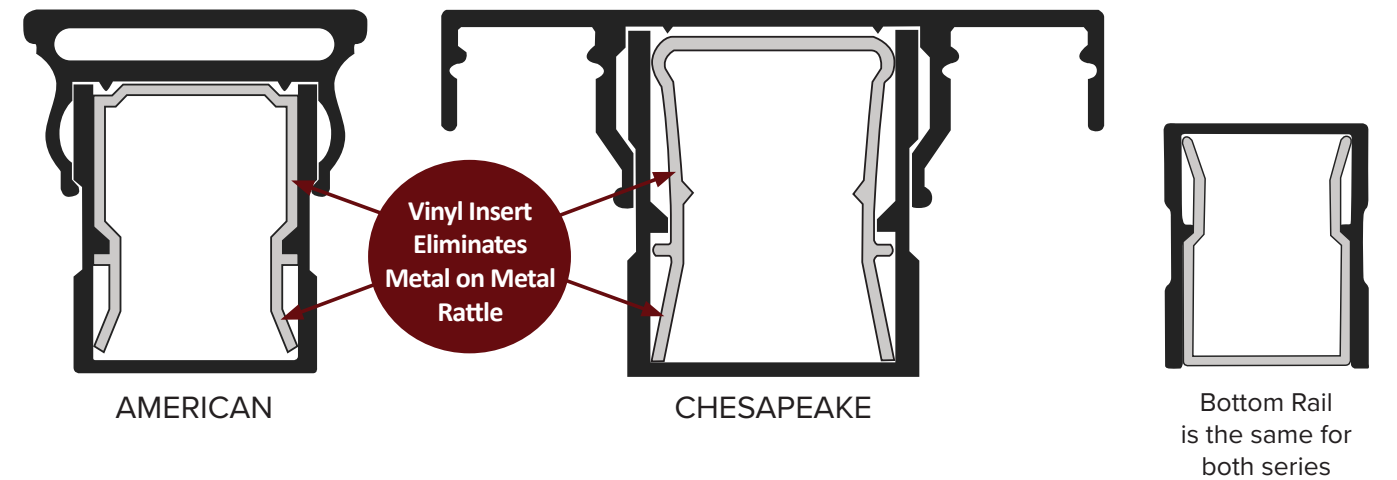

FASCIA MOUNT BRACKETS

Available for both 2½" and 3¼" posts

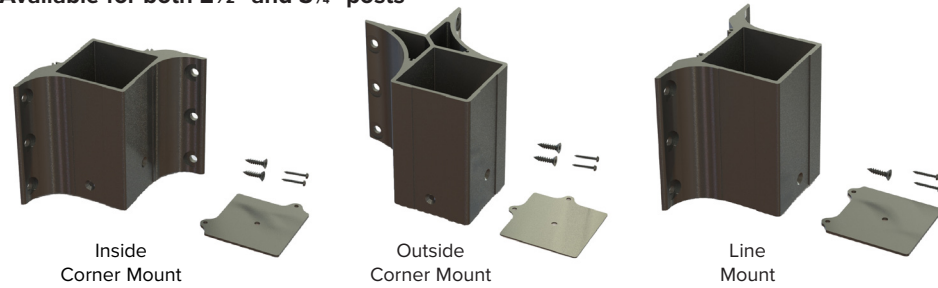

STANDARD COLORS



Special order colors also available.

POST CAPS & TRIM

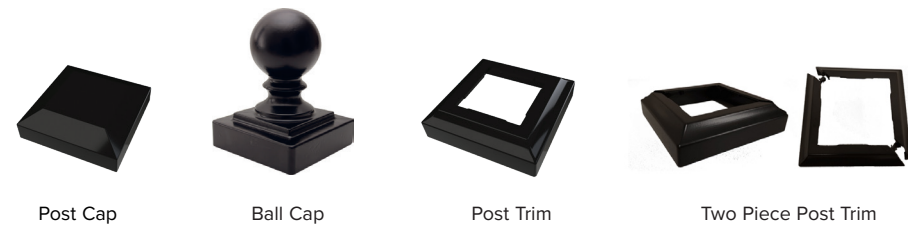

POSTS, POST WRAP

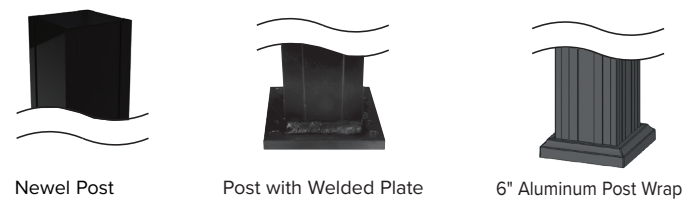

PORCH POSTS

3¼" & 4" Structural Porch Posts

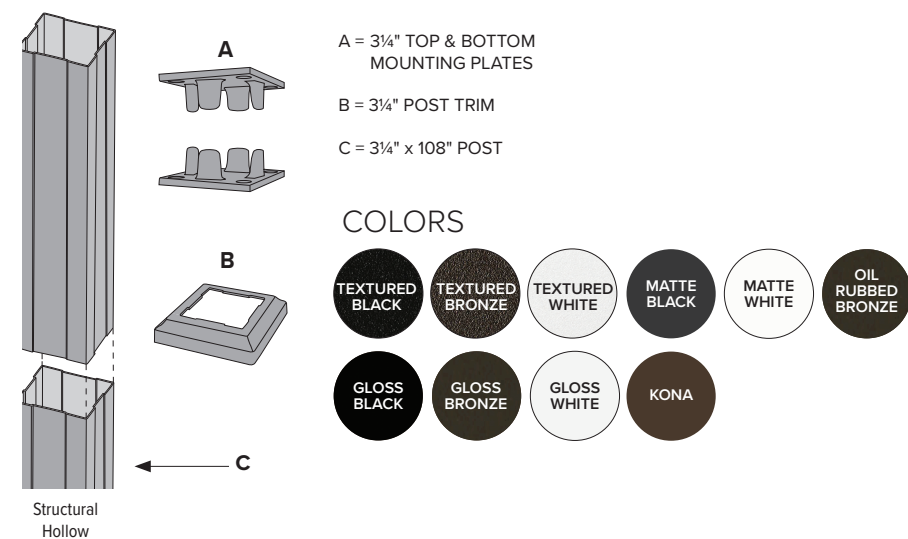

ADA ALUMINUM HANDRAIL

ADA Aluminum Handrail adds safety and security without compromising on looks! This handrail is designed to coordinate perfectly with Key-Link's existing railing for a beautiful, functional, and safe railing system.

















STANDARD COLORS



SPECIAL ORDER COLORS



- A** END CAP 
- B** P-LOOP RETURN 
- C** ADA HANDRAIL BRACKET 
- D** HANDRAIL CONNECTOR WITH RING 
- E** 5° RADIUS ELBOW (24") 
- F** 34° RADIUS ELBOW (24") 
- G** STRAIGHT HANDRAIL (104") 
- H** 90° RADIUS ELBOW (24") 
- I** 6" CORNER MOUNTING BRACKET 
- J** 0° - 90° UNIVERSAL ELBOW 
- K** OUTSIDE ELBOW 
- L** ALUMINUM 90° ELBOW BRACKET 
- M** STRAIGHT ALUMINUM WALL BRACKET WITH RING 
- N** ALUMINUM GATE RETURN (+ O) 
- O** UNIVERSAL ELBOW HANDRAIL BRACKET 



EXTERNAL
CABLE FITTINGS

GIVE YOUR VIEW AN UPGRADE

Cable fittings allow you to turn wood, aluminum, composite, or masonry posts into vehicles for beautiful on-trend horizontal cable railing.

These slimmed down fittings have full tensioning capacity for safety and security and require only a few standard tools for installation.

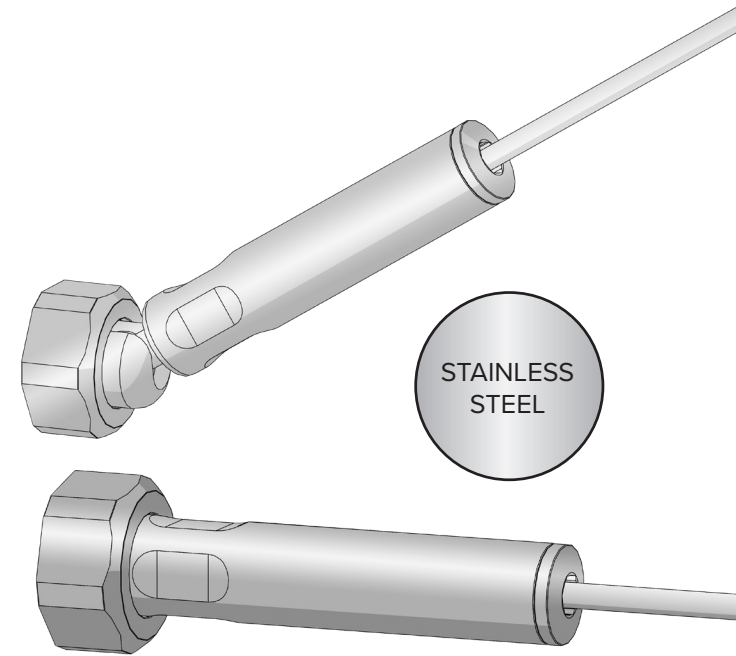

Stair and level fittings available.



BRING YOUR SPACE TO LIGHT

Create stunning focal points and add atmosphere and safety to your outdoor living space with lighting. Key-Link's lighting is designed to pair with railing for a beautiful, seamless look. Post cap and accent lights are made from diecast aluminum and powder-coated with the same coating and color, which means both posts and lights will retain their color in the same way.

Key-Link's electrical engineers and experts have refined our lights for a long-lasting and easy-to-use system that brings exceptional outdoor lighting to your deck or porch.



STANDARD COLORS

Powder-coated die-cast aluminum



SPECIAL ORDER COLOR OPTIONS



POST & ACCENT LIGHTS

Sizes available for 2½", 3¼" and 4" Posts

POST CAP LIGHTS

3000k LED

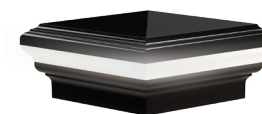

PYRAMID



DECORATIVE

POST CAP DOWNLIGHTS

3000k LED



PYRAMID



DECORATIVE

POST & STAIR ACCENT LIGHT

3000k LED



POST CAPS (NO LIGHTS)

PYRAMID



DECORATIVE

UNDER RAIL LIGHTING

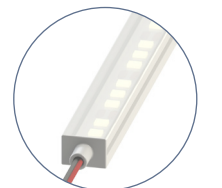

Only available for Chesapeake Series

LIGHTING ACCESSORIES

LIGHTING CONTROL HUB & POWER SUPPLY



- Timer lets you choose 1-9 hours of light, or dusk-to-dawn
- Dimmer mode with 9 brightness levels
- Adjustable photocell sensor to control for ambient light
- **Walk Away** feature for safe exiting before lights go out
- Aluminum housing to match railing
- Power Supply available in 60w or Power Station

POST LIGHT WIRE KIT

- KIT INCLUDES:
- Staples
 - 2-way splitter
 - 5' and 9' wire extensions

WIRE EXTENSIONS, WIRE SPLITTERS

- WIRE EXTENSIONS:
- 2', 5', 9' Lengths Available
- WIRE SPLITTER KITS:
- 2-Way Kit: Includes (1) 8" input cable to (2) 8" output cables
 - 3-Way Kit: Includes (1) 8" input cable to (3) 10" output cables

2" POST ADAPTER

- Made to fit fence posts
- Fits 2" Posts
- Uses 2½" Cap for 2" Post





KEY-LINK™

FENCING & RAILING



[keylinkonline.com](https://www.keylinkonline.com)

260 Jalyn Drive, New Holland, PA 17557

717-355-7130 // Toll Free: 888-704-7130

Fax: 717-355-7139

